

Home Comfort Group



BOSCH

Bosch IDS Family of Inverter Heat Pumps

Maximizes your home comfort while minimizing your energy usage



Bosch Inverter Drive Technology Provides Maximum Comfort, Minimum Energy!

Bosch Inverter Ducted Split Family



The Bosch Inverter Ducted Split Family provides supremely-efficient comfort by adjusting compressor capacity rather than a simple on/off control like other units, thereby reducing operating costs and saving you money. With enhanced humidity control and higher efficiency, the performance of the Bosch IDS Family provides you with maximum comfort with minimal energy usage! Our system's intelligent features work in tandem with your thermostat to automatically adjust to your preferences, while integrated sound dampening features keep the equipment quiet for your peace of mind.

15 SEER System IDS Light



- ▶ The first 15-SEER Inverter condenser on the market.
- ▶ With IDS Light, you get the comfort of our inverter system at a price point you'll love!
- ▶ This system combines the standard efficiency BOVA15 outdoor unit with our BVA15 fixed-speed air handler.

18 SEER System IDS Plus



- ▶ Our most popular system, the IDS Plus, provides the perfect balance of efficiency and comfort, without breaking the bank.
- ▶ This system combines the efficient and reliable BOVB18 outdoor unit with our exceptional BVA20 two stage constant torque ECM style air handler.

20 SEER System IDS Premium



- ▶ Qualify for maximum energy rebates and save the most on energy costs with our highest efficiency offering: IDS Premium.[§]
- ▶ This system combines our top tier BOVA20 outdoor unit with our exceptional BVA20 two stage constant torque ECM style air handler.

20 SEER System IDS Premium Connected⁽¹⁾⁽²⁾



- ▶ Provides the same premium 20-plus SEER energy efficiency.
- ▶ Features wireless connectivity.
- ▶ The Bosch EasyAir app enables in-app product registration, simplifies installation and troubleshooting, and allows remote monitoring of energy usage as well as critical alerts.



Why Choose A Bosch IDS System

Quiet Comfort Achieved

The Bosch Inverter Ducted Split system is one of the quietest air-to-air heat pumps on the market. Through the use of silent blade technology, sound isolating mounts and outdoor condensing section placement - the system can deliver outdoor sound levels as low as 56 dBA - which is far superior to any standard system on the market.

Consume Only the Energy You Need

Modulating inverter systems deliver only the amount of hot or cool air needed to achieve the desired temperature – no more, no less. Bosch's Inverter Ducted Split system can provide you with maximum comfort levels at a minimum cost.

Fast Response

It takes traditional systems a long time to reach the homeowner's desired temperature, while the boosted compressor speed of inverter systems allows for quicker, smoother and more efficient heating and cooling.

Consistent Room Temperature

Conventional heat pumps frequently cycle on and off, resulting in uncomfortable temperature fluctuations. Inverter-driven heat pumps are able to self-adjust, providing consistent room temperature, even when the temperature outdoors dips below freezing.

Energy Use is Even and Steady

The frequent on and off of traditional units creates an in-rush current surge which uses more energy and causes unneeded wear and tear on your system. The Bosch inverter system smoothly ramps up operation, avoiding spikes in energy use and protecting the system's life-cycle.

Residential Limited Warranty[§]

With the residential limited warranty, you receive peace-of-mind knowing you will receive up to 10 years protection on parts and up to 2 years on gateway connectivity components. This standard offering covers all components incorporated into the heat pump system at the time of manufacture. All other components or parts that are purchased from Bosch and installed in the field have a 1-year parts warranty.

Premium Connected HVAC Solution⁽¹⁾⁽²⁾

Featuring wireless connectivity as well as in-app warranty registration, installation, and troubleshooting, the IDS Premium Connected provides an interactive Internet of Things (IoT) platform for contractors and homeowners. Its connected features include:

Remote Monitoring

Allows contractors and homeowners to monitor data for their unit even without a communicating thermostat.

Bosch EasyAir App

Contractors can easily access the information they need to conduct on-site installation, troubleshooting, and warranty registration.



Scan QR with Smartphone to Download App

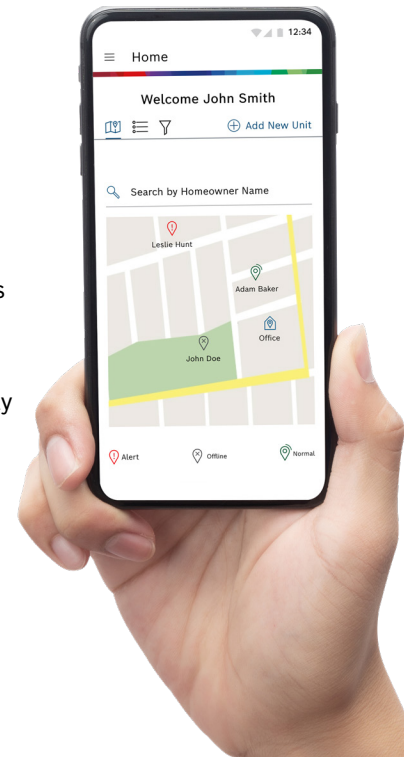

[§] Please go to www.bosch-homecomfort.us for full limited warranty details

(1) The connectivity features are only available in the U.S. (2) These features are offered for 2 years. Afterwards, certain fees may apply.



20 SEER System

**IDS Premium
Connected⁽¹⁾⁽²⁾**



Scan QR with
Smartphone to
Download App



Bosch EasyAir App

Contractor Troubleshooting Made Easy

The Bosch EasyAir app is your one-stop shop for troubleshooting the IDS Premium Connected. With just a few swipes on your phone, you can easily access information about installation, warranty registration, and how to monitor the unit remotely.



Remote Monitoring & Troubleshooting

Monitor the heat pump's health and visualize real time alerts remotely. View fault codes, live check point values and calculate superheat and subcool values that will help in troubleshooting faults quickly.



Get Notified on Systems Faults

Receive alerts on your phone right away about unit errors, warnings, and other important updates.



Manage Your Technicians

As the owner of the company or an office admin that dispatches technicians, you can add installers/technicians to your company profile and manage which homeowner units they can access.



Warranty Registration

Quickly and efficiently register products for warranty at the click of a button in the EasyAir app.

(1) The connectivity features are only available in the U.S. (2) These features are offered for 2 years. Afterwards, certain fees may apply.



Homeowners, Keep Track of Your HVAC System

Bosch EasyAir helps you to monitor your home's energy usage during those hot summer months or cold winter nights. Through the app, you can receive critical alerts directly to your phone and have your contractor information handy to get you up and running as quickly as possible.



Monitor Energy Usage

Track your monthly energy use. Read tips on how to improve efficiency and save energy.



Get Notified on Alerts

Get notified about warnings and alerts regarding your heat pump through the app.



Get Help Faster

Give access to your contractor to get your issue fixed as quickly as possible. Contractor and warranty information is also available through this app.

IDS Family Components Features & Benefits

What is Inverter
Technology?

Scan to Watch Video

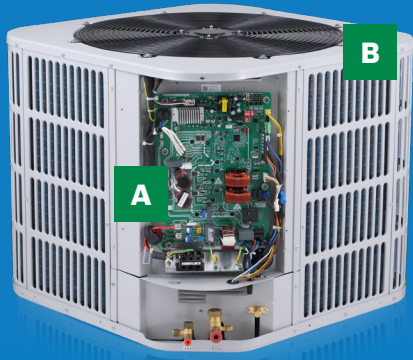

Bosch BOVA15
Outdoor Inverter Condenser

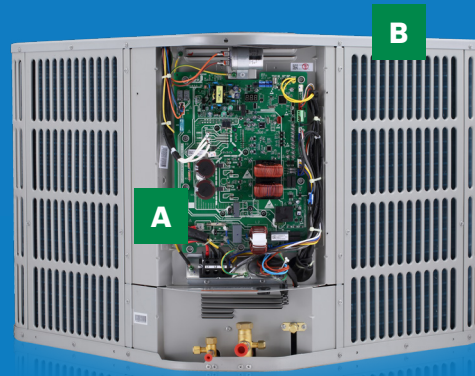

Bosch BOVB18
Outdoor Inverter Condenser

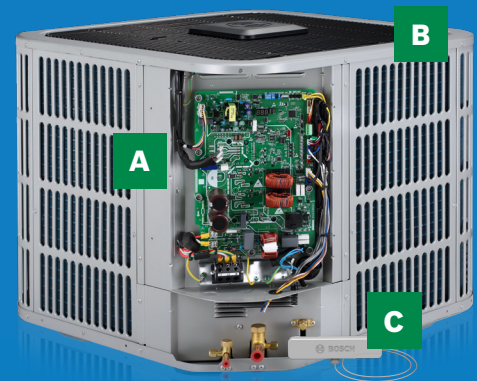

Bosch BOVA20 / BOVB20
High-Efficiency Outdoor Inverter Condenser

A Intelligent control features help adjust the output capacity, allowing the unit to keep the temperature at your desired level without fluctuation and to keep humidity in check during the summer months. Whether it be summer or winter, the system keeps your home comfortable and the living conditions to your desired taste. The BOVA15 condenser has a smaller unit footprint than the BOVB18 and BOVA*20 and also includes an ECM Motor for all capacities (2,3, and 5 ton).

- ▶ The air coil design provides exceptional heat transfer and low air-resistance for high-efficiency operation that can help lower your energy costs.
- ▶ The direct-drive fan blades provide vortex suppression to reduce sound of airflow exiting the condensing section, thereby retaining low noise at high speed - with sound levels as low as 56 dBA for BOVB18, 59 dBA for BOVA15.
- ▶ The condensing units come standard with an electronic expansion valve (EEV) to ensure proper refrigerant flow during all conditions. This helps optimize the unit's operation to the highest efficiency possible.

B The high-efficiency variable capacity inverter compressor in the condensers can adjust to speeds ranging from 26% to 130% to perfectly cool and heat your home using minimal energy for maximum comfort.

- ▶ BOVA15 can adjust to any speed between 33% and 110% (in 1% increments).
- ▶ BOVB18 can adjust to any speed between 26% and 110% (in 1% increments).
- ▶ BOV*20 can adjust to any speed between 36% and 130%. (in 1% increments).

C Featuring wireless connectivity as well as in-app warranty registration, installation, and troubleshooting, the IDS Premium Connected provides an interactive Internet of Things (IoT) platform for contractors and homeowners.

Built on the foundation of the IDS Premium 20 SEER outdoor unit, the IDS Premium Connected enables connectivity features while offering the same performance and comfort as the existing model.

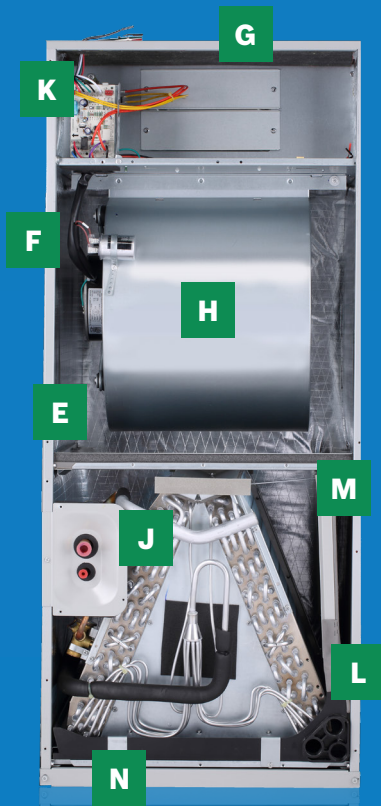

Bosch BVA15

Robust & Reliable Indoor Air Handler

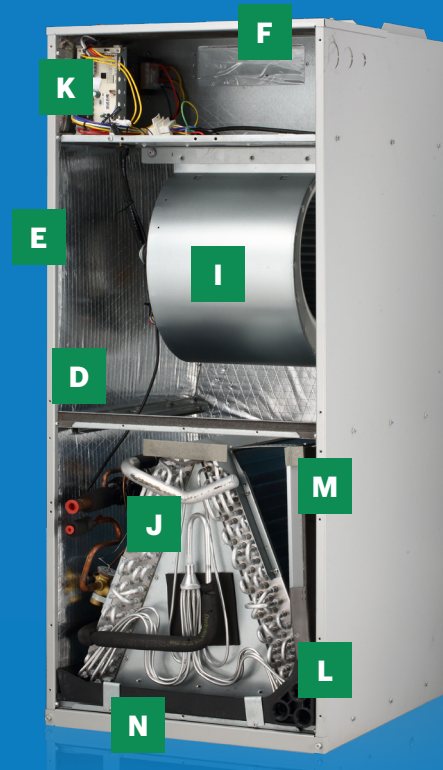

Bosch BVA20

High-Efficiency & Reliable Indoor Air Handler

- E** Material – Foil-faced insulation material on the inner walls decreases energy loss and reduces condensation.
- F** Cabinets – Painted galvanized steel cabinet is salt spray tested for improved durability and corrosion-resistance.
- G** Electric Heat – Can accommodate electric heat with no modification to the cabinet for additional heat on-demand when you need it most.
- H** PSC style motor in the Bosch BVA15 – simple and cost-effective solution.
- I** Two-stage ECM motor in the Bosch BVA20 – Indoor blower stages up and down to provide enhanced comfort, energy savings, and superior humidity control.
- J** All-Aluminum Coil – With excellent heat transfer, efficiency, and humidity removal, the A-coil is more durable and has a lower chance of refrigerant leakage compared to typical copper coils.
- K** Control Board Pocket – A dedicated slot for the control board protects it from humidity in the airstream and extends its lifetime.
- L** Integrated Drain Pan – Made from corrosion-resistant composite material, gently sloped to reduce standing water.
- M** Drain Pan – Flexibility for VT or HZ applications.
- N** Filter Rack – Factory reserved, provides convenience for field installation and serviceability.



Before Everything, There's Bosch.

Bosch Offers Reliable Energy Efficient HVAC Products,
That are Simple to Install and Support Readily Available!



The Bosch IDS Family was designed for homeowners that want a reliable HVAC system, that will produce exceptional and efficient heating and cooling year round backed with a 10-Year warranty. §

 **BOSCH**

Bosch Has Developed and Built The Perfect HVAC System For Your Home

Bosch IDS systems utilize just the right amount of energy to achieve ultimate comfort year after year, all while keeping sound levels to a minimum. Choose the Bosch IDS system that is right for you and enjoy our peace of mind 10 Year Bosch warranty![§]

Bosch IDS Family

- ▶ IDS Light up to 16.0 SEER | 9 HSPF
- ▶ IDS Plus up to 18.5 SEER | 9.5 HSPF
- ▶ IDS Premium up to 20.5 SEER | 10.5 HSPF
- ▶ IDS Premium Connected up to 20.5 SEER | 10.5 HSPF
- ▶ Fully-modulating inverter drive
- ▶ Sound levels as low as 56 dBA⁽¹⁾
- ▶ 8 Air handlers – 2, 3, 4, 5 Ton
- ▶ 9 Condensing units – 2, 3, 5 Ton
- ▶ Compatible with most 24 VAC thermostats
- ▶ Bosch engineering & quality
- ▶ Designed and tested to Bosch standards
- ▶ 10-year residential limited warranty[§]

Installer Friendly

- ▶ Designed for easy installation
- ▶ Intuitive controls
- ▶ Support readily available
- ▶ Spare parts readily available
- ▶ Easy to maintain and service
- ▶ On-board diagnostics
- ▶ In-app guides to assist installation⁽³⁾



IDS Portfolio Pairing

Refer to this chart below for full portfolio combination availability. In addition to the IDS Light, Plus, and Premium, we also offer other matches to maximize system flexibility.

IDS PORTFOLIO PAIRING		OUTDOOR UNIT		
		IDS LIGHT (BOVA15)	IDS PLUS (BOVB18)	PREMIUM / PREMIUM CONNECTED (BOV*20)
Indoor unit	BVA15	✓	✓	-
	BVA20	✓	✓	✓
	Cased Coil Only	-	✓	✓
	BGH96 + Cased Coil	✓	✓	✓

(1) 56 dBA sound level is based on outdoor unit. § Please go to www.bosch-homecomfort.us for full limited warranty details (3) only available with IDS Premium Connected

Choose the System That's Right For You

Quality engineering, quiet performance and an unbeatable warranty from Bosch delivers exceptional home comfort. Whether heating or cooling, our reliable inverter heat pumps keep homeowners comfortable by providing precise indoor temperature and humidity control. These high-efficiency, robust and quiet Inverter Ducted Split system heat pumps are available in four sizes ranging from 2 to 5 ton capacity to suit your needs. This system boasts a inverter drive which adjusts the speed of the compressor to optimize comfort, while keeping sound levels to a minimum and utilizing the right amount of energy to achieve maximum comfort.





IDS Light BOVA15 + BVA15 15 SEER System

- ▶ The first 15-SEER Inverter condenser solution on the market. With IDS Light, you get the comfort of our inverter system at a price point you'll love!
- ▶ This system combines the robust design & efficiency BOVA15 outdoor unit with our BVA15 fixed-speed air handler.

IDS LIGHT BOVA15 + BVA15 AHRI 210/240 - 2017 PERFORMANCE DATA

OUTDOOR UNIT MODEL	INDOOR AIR HANDLER MODEL	COOLING CAPACITY (BTU/H)			HEATING CAPACITY (BTU/H)			CFM
		TOTAL	EER ⁽³⁾	SEER ⁽⁴⁾	HI	HSPF ⁽⁵⁾	LOW	
BOVA-24HDN1-M15G	BVA-24WN1-M15	24000	11.2	15.5	24000	9.0	20000	830
BOVA-36HDN1-M15G	BVA-24WN1-M15	24000	11.8	16.0	24000	9.0	20500	830
BOVA-36HDN1-M15G	BVA-36WN1-M15	34200	10.4	15.0	35000	9.0	25000	1220
BOVA-60HDN1-M15G	BVA-48WN1-M15	46500	11.2	15.0	48000	9.0	38000	1530
BOVA-60HDN1-M15G	BVA-60WN1-M15	50000	10.2	15.0	56000	9.0	40500	1810

IDS LIGHT BOVA15 + BVA15 AHRI 210/240 - 2023 PERFORMANCE DATA

OUTDOOR UNIT MODEL	INDOOR AIR HANDLER MODEL	COOLING CAPACITY (BTU/H)			HEATING CAPACITY (BTU/H)			CFM
		TOTAL	EER2 ⁽³⁾	SEER2 ⁽⁴⁾	HI	HSPF2 ⁽⁵⁾	LOW	
BOVA-24HDN1-M15G	BVA-24WN1-M15	24000	10.6	14.5	24000	8	20000	780
BOVA-36HDN1-M15G	BVA-24WN1-M15	24000	11.2	14.8	24000	8.2	20600	780
BOVA-36HDN1-M15G	BVA-36WN1-M15	34200	10	14.5	34600	8	25000	1210
BOVA-60HDN1-M15G	BVA-48WN1-M15	46500	10.6	14.3	48000	8	38000	1530
BOVA-60HDN1-M15G	BVA-60WN1-M15	54500	9.8	14.3	56000	8	40500	1680



IDS Plus BOVB18 + BVA20 18 SEER System

- ▶ The IDS Plus provides the perfect balance of efficiency and comfort, without breaking the bank.
- ▶ This system combines the BOVB18 outdoor unit with our exceptional BVA20 two stage constant torque ECM style air handler.

IDS PLUS BOVB18 + BVA20 AHRI 210/240 - 2017 PERFORMANCE DATA

OUTDOOR UNIT MODEL	INDOOR AIR HANDLER MODEL	COOLING CAPACITY (BTU/H)			HEATING CAPACITY (BTU/H)			CFM
		TOTAL	EER ⁽³⁾	SEER ⁽⁴⁾	HI	HSPF ⁽⁵⁾	LOW	
BOVB-36HDN1-M18M	BVA-24WN1-M20	24000	13	18.5	24000	9.5	21600	860/680
BOVB-36HDN1-M18M	BVA-36WN1-M20	34200	10.8	17.5	34200	9	25000	1150/820
BOVB-60HDN1-M18M	BVA-36WN1-M20	35200	12.5	18.5	35200	10.5	24000	1150/820
BOVB-60HDN1-M18M	BVA-48WN1-M20	47000	12.5	18.5	46500	9.5	38000	1530/1150
BOVB-60HDN1-M18M	BVA-60WN1-M20	56000	10.8	17.5	55000	9.5	40500	1750/1350

IDS PLUS BOVB18 + BVA20 AHRI 210/240 - 2023 PERFORMANCE DATA

OUTDOOR UNIT MODEL	INDOOR AIR HANDLER MODEL	COOLING CAPACITY (BTU/H)			HEATING CAPACITY (BTU/H)			CFM
		TOTAL	EER2 ⁽³⁾	SEER2 ⁽⁴⁾	HI	HSPF2 ⁽⁵⁾	LOW	
BOVB-36HDN1-M18M	BVA-24WN1-M20	24000	11.7	17.5	24000	8.2	21000	700/540
BOVB-36HDN1-M18M	BVA-36WN1-M20	33800	10.2	17.5	35000	8.5	25000	1220/780
BOVB-60HDN1-M18M	BVA-36WN1-M20	35200	12.0	18.0	35200	8.2	25000	1220/780
BOVB-60HDN1-M18M	BVA-48WN1-M20	45000	11.7	17.5	47000	9.0	38000	1580/1100
BOVB-60HDN1-M18M	BVA-60WN1-M20	55000	10.2	17.0	57000	9.0	40500	1720/1310

Blue Text = ENERGY STAR Certified V6.1. ❄️ = ENERGY STAR V6.1 Cold Climate and ENERGY STAR V6.1 certified. (3) Energy Efficiency Ratio; Certified per AHRI 210/240. (4) Seasonal Energy Efficiency Ratio; Certified per AHRI 210/240. (5) HSPF = Heating Seasonal Performance Factor; Certified per AHRI 210/240. Note: Always check the rating plate for electrical data on the unit being installed. The listed data is for reference only. Please consult www.bosch-homecomfort.us for further details. ♦ Visit www.bosch-homecomfort.us to find the available efficiency rebates in your area.



IDS Premium / Premium Connected BOV*20 + BVA20 20 SEER System

- ▶ Qualify for maximum energy rebates and save the most on energy costs with our highest efficiency: IDS Premium.◊
- ▶ This system combines our top tier BOV*20 outdoor unit with our exceptional BVA20 two stage constant torque ECM style air handler.

IDS PREMIUM BOV*20 + BVA20 AHRI 210/240 - 2017 PERFORMANCE DATA

OUTDOOR UNIT MODEL	INDOOR AIR HANDLER MODEL	COOLING CAPACITY (BTU/H)			HEATING CAPACITY (BTU/H)			CFM
		TOTAL	EER ⁽³⁾	SEER ⁽⁴⁾	HI	HSPF ⁽⁵⁾	LOW	
BOV*-36HDN1-M20G	BVA-24WN1-M20	24000	14	20.5	24000	10.5	23000	860/680
BOV*-36HDN1-M20G	BVA-36WN1-M20	34600	12.5	20	34200	10.5	28000	1150/820
BOV*-60HDN1-M20G	BVA-48WN1-M20	47500	13.5	20	48000	10.5	40000	1530/1150
BOV*-60HDN1-M20G	BVA-60WN1-M20	54500	12.5	19	56000	10.5	44000	1750/1350

IDS PREMIUM BOV*20 + BVA20 AHRI 210/240 - 2023 PERFORMANCE DATA

OUTDOOR UNIT MODEL	INDOOR AIR HANDLER MODEL	COOLING CAPACITY (BTU/H)			HEATING CAPACITY (BTU/H)			CFM
		TOTAL	EER ⁽³⁾	SEER ⁽⁴⁾	HI	HSPF ⁽⁵⁾	LOW	
❄️ BOV*-36HDN1-M20G	BVA-24WN1-M20	24000	13.0	20.0	24000	9.5	22400	720/560
BOV*-36HDN1-M20G	BVA-36WN1-M20	34200	12.0	19.0	34200	9.5	28000	1170/880
❄️ BOV*-60HDN1-M20G	BVA-48WN1-M20	47000	12.0	18.5	48000	9.5	40000	1580/1100
BOV*-60HDN1-M20G	BVA-60WN1-M20	52000	11.7	18.0	55000	9.5	43500	1720/1310

Blue Text = ENERGY STAR Certified V6.1. ❄️ = ENERGY STAR V6.1 Cold Climate and ENERGY STAR V6.1 certified. (3) Energy Efficiency Ratio; Certified per AHRI 210/240. (4) Seasonal Energy Efficiency Ratio; Certified per AHRI 210/240. (5) HSPF = Heating Seasonal Performance Factor; Certified per AHRI 210/240. Note: Always check the rating plate for electrical data on the unit being installed. The listed data is for reference only. Please consult www.bosch-homecomfort.us for further details. ◊ Visit www.bosch-homecomfort.us to find the available efficiency rebates in your area.

“Bosch is the leading source of high-quality heating, cooling and hot water systems and that’s why I am only installing Bosch products on my next projects”

– MIKE HOLMES



IDS Family System & Technical Information

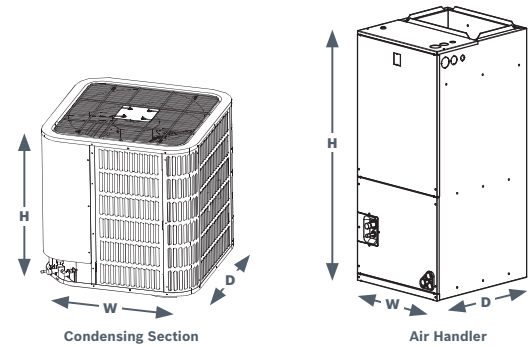

BOSCH IDS FAMILY DESCRIPTION & DIMENSIONS[®]

MODEL NUMBER	DESCRIPTION	PART NUMBER	WIDTH (W)	HEIGHT (H)	DEPTH (D)
BOVA15 OUTDOOR CONDENSING SECTION					
NEW BOVA-24HDN1-M15G	24 kBTU/hr (2 ton)	8733956368	28	24.9375	28
NEW BOVA-36HDN1-M15G	36 kBTU/hr (3 ton)	8733955693	28	24.9375	28
NEW BOVA-60HDN1-M15G	60 kBTU/hr (5 ton)	8733955694	29.125	33.1875	29.125
BOVB18 OUTDOOR CONDENSING SECTION					
BOVB-36HDN1-M18M	36 kBTU/hr (3 ton)	8733955036	29.125	24.9375	29.125
BOVB-60HDN1-M18M	60 kBTU/hr (5 ton)	8733955037	29.125	33.1875	29.125
BOVA20 OUTDOOR CONDENSING SECTION					
BOVA-36HDN1-M20G	36 kBTU/hr (3 ton)	8733952437	29.125	24.9375	29.125
BOVA-60HDN1-M20G	60 kBTU/hr (5 ton)	8733952438	29.125	33.1875	29.125
BOVB20 OUTDOOR CONDENSING SECTION					
NEW BOVB-36HDN1-M20G	36 kBTU/hr (3 ton)	8733955689	29.125	24.9375	29.125
NEW BOVB-60HDN1-M20G	60 kBTU/hr (5 ton)	8733955690	29.125	33.1875	29.125
BVA15 INDOOR AIR HANDLER					
BVA-24WN1-M15	24 kBTU/hr (2 ton)	8733955038	19.625	46.5	21.625
BVA-36WN1-M15	36 kBTU/hr (3 ton)	8733955039	19.625	46.5	21.625
BVA-48WN1-M15	48 kBTU/hr (4 ton)	8733955040	22.0	54.5	24.0
BVA-60WN1-M15	60 kBTU/hr (5 ton)	8733955041	22.0	54.5	24.0
BVA20 INDOOR AIR HANDLER					
BVA-24WN1-M20	24 kBTU/hr (2 ton)	8733952439	19.625	46.5	21.625
BVA-36WN1-M20	36 kBTU/hr (3 ton)	8733952440	19.625	46.5	21.625
BVA-48WN1-M20	48 kBTU/hr (4 ton)	8733952441	22.0	54.5	24.0
BVA-60WN1-M20	60 kBTU/hr (5 ton)	8733952442	22.0	54.5	24.0

IDS FAMILY FIELD INSTALLED ELECTRIC HEAT KITS

MODEL NUMBER	PART NUMBER	DESCRIPTION
EHK-05B	7739832075	5 kW Electric Strip Heater
EHK-08B	7739832076	7.5 kW Electric Strip Heater
EHK-10B	7739832077	10 kW Electric Strip Heater
EHK-15B	7739832078	15 kW Electric Strip Heater
EHK-20B	7739832079	20 kW Electric Strip Heater



Bosch IDS Dual Fuel Provides Optimal Comfort Every Season!

The Ideal Solution For Maximize Comfort & Efficiency

Bosch offers a complete dual fuel heating and cooling system for your home. Dual fuel systems are the ideal solution to maximize comfort and efficiency. In the summer, the Bosch IDS efficiently cools and dehumidifies your home. In the shoulder seasons, the IDS system will provide the exact amount of heating or cooling that your home requires -- no more, no less. In the colder months, the system senses when it is more economical for the heat pump to shut off and the Bosch BGH96 gas furnace to take over. Installing a Bosch matched dual fuel system is the best choice to optimize both savings and comfort.



Outdoor Unit BOVA20

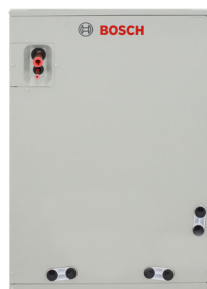

BMAC Cased Coil



BGH96 Furnace

BGH96
Product
Brochure



Scan or Click QR



The Complete & Highly Efficient Dual Fuel Heating and Cooling System For Your Home



A BOVA15, BOVB18, or BOV*20 Outdoor Unit*

The robust Bosch Inverter Ducted Split Air Source Heat Pump system utilizes just the right amount of energy to achieve ultimate comfort and maximum efficiency while keeping sound levels to a minimum. Choose between the BOVA15, BOVB18, or BOV*20 for maximum efficiency.



C Bosch BGH96 96% Furnace*

The BGH96 Gas Furnace offers up to 96% efficiency, a two-stage gas valve, and a multi-speed blower. This ENERGY STAR rated furnace offers premium comfort and energy savings, it is the perfect solution to efficiently heat your home.



B Bosch BMAC Cased Coil*

The Inverter Ducted Split Cased Coil, when paired with a Bosch Furnace and IDS outdoor condensing section, delivers some of the best comfort levels and efficiency on the market today. Bosch offers a complete range of cased coils to fit your needs.



D Bosch BCC100 Wi-fi Thermostat*

The BCC100 is a sleek, internet-connected thermostat that offers easy all-in-one control for your heating and cooling systems. It can be controlled using the Bosch Connected Control app and is compatible with most 24VAC HVAC equipment on the market.

* Products sold separately

Why Choose Bosch Dual Fuel

System Efficiency

Dual fuel systems are the ideal solution to maximize comfort and efficiency. Bosch offers a complete dual fuel system with the Bosch Inverter Ducted Split (IDS) heat pump, Bosch BMAC cased coil, Bosch 96% AFUE Gas Furnace and the Bosch Connected Control thermostat. In the summer, the Bosch IDS efficiently cools and dehumidifies your home. In the shoulder seasons, the IDS system will provide the exact amount of heating or cooling that your home requires, no more, no less. In the colder months, the system senses when it is more economical for the heat pump to shut off and the Bosch BGH96 gas furnace to take over. Installing a Bosch matched dual fuel system is the best choice to optimize both savings and comfort.

Savings

Homeowners will see the savings on their energy bills by converting up to 96% of the fuel purchased to heat their home. The furnace's two-stage gas valve switches between high and low fire settings, allowing enhanced comfort and more efficient operation than single stage technology.

Residential Limited Warranty**

With the residential limited warranty, you receive peace-of-mind knowing you will receive replacement parts protection for up to 5 years and up to 20 years on the heat exchanger. This offering covers all components incorporated into the BGH96 Furnace at the time of manufacture. All other components or parts that are purchased from Bosch and installed in the field have a 1 year parts warranty.



Dual Fuel System & Technical Information

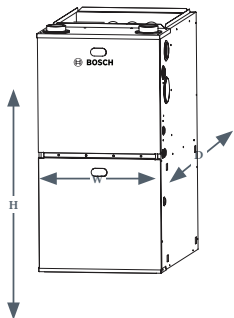

BGH96 FURNACE DIMENSIONS ^o				
MODEL NUMBER	PART NUMBER	WIDTH (W)	HEIGHT (H)	DEPTH (D)
BGH96M060B3B	7-738-007-227	17.5	33-3/4	28-1/2
BGH96M080B3B	7-738-007-228			
BGH96M080C4B	7-738-007-229	21		
BGH96M100C5B	7-738-007-230	24.5		
BGH96M100D5B	7-738-007-231			
BGH96M120D5B	7-738-007-232			

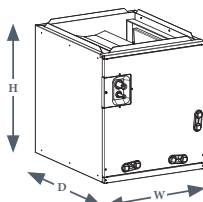

BMAC CASED COIL DIMENSIONS ^o		CASED			UNCASED		
MODEL NUMBER	PART NUMBER	WIDTH (W)	HEIGHT (H)	DEPTH (D)	WIDTH (W)	HEIGHT (H)	DEPTH (D)
BMAC2430ANTD	8733947947	14.5	20.0	21.0	13.375	15.625	20.5
BMAC2430BNTD	8733947948	17.5	20.0	21.0	16.375	15.375	20.5
BMAC3036ANTD	8733947950	14.5	20.0	21.0	13.375	15.625	20.5
BMAC3036BNTD	8733947951	17.5	20.0	21.0	16.375	15.375	20.5
BMAC3036CNTD	8733947952	21.0	20.0	21.0	19.875	15.25	20.5
BMAC4248BNTF	8733947953	17.5	30.0	21.0	16.375	26.88	21.0
BMAC4248CNTF	8733947954	21.0	30.0	21.0	19.875	26.8	21.0
BMAC4248DNTF	8733947955	24.5	30.0	21.0	23.625	26.6	21.0
BMAC4860CNTF	8733947956	21.0	30.0	21.0	19.875	27.0	21.0
BMAC4860DNTF	8733947957	24.5	30.0	21.0	23.625	26.8	21.0

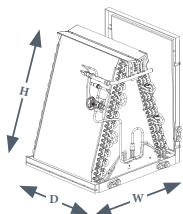

^oUncased Coil Dimensions are shown for reference should the casing be removed in the field.

BOVA15 OUTDOOR UNIT + BMAC CASED COIL + BGH96 FURNACE AHRI 210/240 - 2017 PERFORMANCE DATA

OUTDOOR UNIT MODEL	CASED COIL MODEL	PAIRING FURNACES	COOLING CAPACITY (BTU/H)			HEATING CAPACITY (BTU/H)			CFM
			TOTAL	EER ⁽³⁾	SEER ⁽⁴⁾	HI	HSPF ⁽⁵⁾	LOW	
BOVA-24HDN1-M15G	BMAC2430ANTD	BGH96M060B3B	23600	11.5	16.5	24000	9	17600	720/630
BOVA-24HDN1-M15G	BMAC2430ANTD	BGH96M080B3B	23600	11.5	16.5	24000	9	17600	700/610
BOVA-24HDN1-M15G	BMAC2430BNTD	BGH96M060B3B	24000	11.5	16.5	24000	9	17600	720/630
BOVA-24HDN1-M15G	BMAC2430BNTD	BGH96M080B3B	24000	11.5	16.5	24000	9	17600	700/610
BOVA-36HDN1-M15G	BMAC3036ANTD	BGH96M060B3B	33000	10	16.5	34200	8.8	23000	1000/750
BOVA-36HDN1-M15G	BMAC3036ANTD	BGH96M080B3B	33000	10	16.5	34200	8.8	23000	1000/750
BOVA-36HDN1-M15G	BMAC3036BNTD	BGH96M060B3B	33600	10	16.5	34200	8.8	23000	1050/770
BOVA-36HDN1-M15G	BMAC3036BNTD	BGH96M080B3B	33600	10	16.5	34200	8.8	23000	1050/770
BOVA-36HDN1-M15G	BMAC3036CNTD	BGH96M080C4B	33600	10	16.5	34200	8.8	23000	1030/750
BOVA-36HDN1-M15G	BMAC3036CNTD	BGH96M100C5B	34000	10	16.5	34200	8.8	23000	1150/750
BOVA-60HDN1-M15G	BMAC4248BNTF	BGH96M080B3B	43000	10	16.5	45000	8.8	31000	1250/1050
BOVA-60HDN1-M15G	BMAC4248CNTF	BGH96M080C4B	43000	10.5	16.5	45000	8.8	31000	1250/1050
BOVA-60HDN1-M15G	BMAC4248CNTF	BGH96M100C5B	45000	10.5	16.5	46500	8.8	32000	1470/1200
BOVA-60HDN1-M15G	BMAC4248DNTF	BGH96M100D5B	45500	10.5	16.5	47000	8.8	32000	1500/1200
BOVA-60HDN1-M15G	BMAC4248DNTF	BGH96M120D5B	45500	10.5	16.5	47000	8.8	32000	1500/1200
BOVA-60HDN1-M15G	BMAC4860CNTF	BGH96M100C5B	53000	9.5	16	53500	9	38000	1660/1150
BOVA-60HDN1-M15G	BMAC4860DNTF	BGH96M100D5B	53500	10	16.5	54000	9	38000	1700/1200
BOVA-60HDN1-M15G	BMAC4860DNTF	BGH96M120D5B	53500	10	16.5	54000	9	38000	1700/1200

BOVA15 OUTDOOR UNIT + BMAC CASED COIL + BGH96 FURNACE AHRI 210/240 - 2023 PERFORMANCE DATA

OUTDOOR UNIT MODEL	CASED COIL MODEL	PAIRING FURNACES	COOLING CAPACITY (BTU/H)			HEATING CAPACITY (BTU/H)			CFM
			TOTAL	EER2 ⁽³⁾	SEER2 ⁽⁴⁾	HI	HSPF2 ⁽⁵⁾	LOW	
BOVA-24HDN1-M15G	BMAC2430ANTD	BGH96M060B3B	23600	10.5	16	24000	8	17600	750/560
BOVA-24HDN1-M15G	BMAC2430ANTD	BGH96M080B3B	23600	10.5	16	24000	8	17600	750/560
BOVA-24HDN1-M15G	BMAC2430BNTD	BGH96M060B3B	24000	10.5	16	24000	8	17600	750/560
BOVA-24HDN1-M15G	BMAC2430BNTD	BGH96M080B3B	24000	10.5	16	24000	8	17600	750/560
BOVA-36HDN1-M15G	BMAC3036ANTD	BGH96M060B3B	33000	9	15.5	34200	7.8	23000	1050/750
BOVA-36HDN1-M15G	BMAC3036ANTD	BGH96M080B3B	33000	9	15.5	34200	7.8	23000	1050/750
BOVA-36HDN1-M15G	BMAC3036BNTD	BGH96M060B3B	33600	9	15.5	34200	7.8	23000	1050/780
BOVA-36HDN1-M15G	BMAC3036BNTD	BGH96M080B3B	33600	9	15.5	34200	7.8	23000	1050/780
BOVA-36HDN1-M15G	BMAC3036CNTD	BGH96M080C4B	33600	9	15.5	34200	7.8	23000	1050/780
BOVA-36HDN1-M15G	BMAC3036CNTD	BGH96M100C5B	33600	9	15.5	34200	7.8	23000	1050/650
BOVA-36HDN1-M15G	BMAC4248BNTF	BGH96M080B3B	33600	9	15.5	34200	7.8	23000	1050/780
BOVA-36HDN1-M15G	BMAC4248CNTF	BGH96M100C5B	33600	9	15.5	34200	7.8	23000	1050/650
BOVA-60HDN1-M15G	BMAC4248BNTF	BGH96M080B3B	43000	9	16	44000	7.8	30000	1100/950
BOVA-60HDN1-M15G	BMAC4248CNTF	BGH96M080C4B	43000	9.5	16	44000	7.8	30000	1150/950
BOVA-60HDN1-M15G	BMAC4248CNTF	BGH96M100C5B	45000	9.5	16	47000	7.8	32000	1600/1100
BOVA-60HDN1-M15G	BMAC4248DNTF	BGH96M100D5B	45500	9.5	16	47000	7.8	32000	1600/1100
BOVA-60HDN1-M15G	BMAC4248DNTF	BGH96M120D5B	45500	9.5	16	47000	7.8	32000	1600/1100
BOVA-60HDN1-M15G	BMAC4860CNTF	BGH96M100C5B	53000	9	15.5	53500	8	38000	1700/1350
BOVA-60HDN1-M15G	BMAC4860DNTF	BGH96M100D5B	53500	9.5	15.5	54000	8	38000	1700/1400
BOVA-60HDN1-M15G	BMAC4860DNTF	BGH96M120D5B	53500	9.5	15.5	54000	8	38000	1700/1400

Blue Text = ENERGY STAR Certified V6.1. * = ENERGY STAR V6.1 Cold Climate and ENERGY STAR V6.1 certified. (3) Energy Efficiency Ratio; Certified per AHRI 210/240. (4) Seasonal Energy Efficiency Ratio; Certified per AHRI 210/240. (5) HSPF = Heating Seasonal Performance Factor; Certified per AHRI 210/240. Note: Always check the rating plate for electrical data on the unit being installed. The listed data is for reference only. Please consult www.bosch-homecomfort.us for further details. NOTICE: Bosch's BGH96 96% Furnace is not to be sold or installed in the State of California in the South Coast Air Quality Management District or San Joaquin Valley Air Basin territory.

BOVB18 OUTDOOR UNIT + BMAC CASED COIL + BGH96 FURNACE AHRI 210/240 - 2017 PERFORMANCE DATA

OUTDOOR UNIT MODEL	CASED COIL MODEL	PAIRING FURNACES	COOLING CAPACITY (BTU/H)			HEATING CAPACITY (BTU/H)			CFM
			TOTAL	EER ⁽³⁾	SEER ⁽⁴⁾	HI	HSPF ⁽⁵⁾	LOW	
BOVB-36HDN1-M18M	BMAC2430ANTD	BGH96M060B3B	23600	12.5	18	24000	9.5	17200	820/630
BOVB-36HDN1-M18M	BMAC2430ANTD	BGH96M080B3B	23600	12.5	18	24000	9.5	17200	800/580
BOVB-36HDN1-M18M	BMAC2430BNTD	BGH96M060B3B	24000	12.5	18	24000	9.5	17200	860/680
BOVB-36HDN1-M18M	BMAC2430BNTD	BGH96M080B3B	24000	12.5	18	24000	9.5	17200	840/630
BOVB-36HDN1-M18M	BMAC3036ANTD	BGH96M060B3B	33000	10.5	16.5	34200	9	22600	1050/800
BOVB-36HDN1-M18M	BMAC3036ANTD	BGH96M080B3B	33000	10.5	16.5	34200	9	22600	1020/800
BOVB-36HDN1-M18M	BMAC3036BNTD	BGH96M060B3B	33600	10.6	16.5	34200	9	23000	1100/850
BOVB-36HDN1-M18M	BMAC3036BNTD	BGH96M080B3B	33600	10.6	16.5	34200	9	23000	1070/850
BOVB-36HDN1-M18M	BMAC3036CNTD	BGH96M080C4B	34000	10.6	16.5	34200	9	23000	1050/820
BOVB-36HDN1-M18M	BMAC3036CNTD	BGH96M100C5B	34000	10.6	16.5	34200	9	23000	1150/750
BOVB-60HDN1-M18M	BMAC4248BNTF	BGH96M080B3B	43000	10.5	17.5	45500	9	31000	1250/1050
BOVB-60HDN1-M18M	BMAC4248CNTF	BGH96M080C4B	43000	11	18	45500	9	31000	1250/1050
BOVB-60HDN1-M18M	BMAC4248CNTF	BGH96M100C5B	45000	11.2	18	47000	9	31400	1450/1150
BOVB-60HDN1-M18M	BMAC4248DNTF	BGH96M100D5B	45500	11.2	18	47000	9	32000	1500/1200
BOVB-60HDN1-M18M	BMAC4248DNTF	BGH96M120D5B	45500	11.2	18	47000	9	32000	1500/1200
BOVB-60HDN1-M18M	BMAC4860CNTF	BGH96M100C5B	52500	10	17	53500	9.5	37000	1450/1150
BOVB-60HDN1-M18M	BMAC4860DNTF	BGH96M100D5B	53000	10.5	17.5	54000	9.5	38000	1500/1200
BOVB-60HDN1-M18M	BMAC4860DNTF	BGH96M120D5B	53000	10.5	17.5	54000	9.5	38000	1500/1200

BOVB18 OUTDOOR UNIT + BMAC CASED COIL + BGH96 FURNACE AHRI 210/240 - 2023 PERFORMANCE DATA

OUTDOOR UNIT MODEL	CASED COIL MODEL	PAIRING FURNACES	COOLING CAPACITY (BTU/H)			HEATING CAPACITY (BTU/H)			CFM
			TOTAL	EER ⁽³⁾	SEER ²⁽⁴⁾	HI	HSPF ²⁽⁵⁾	LOW	
BOVB-36HDN1-M18M	BMAC2430ANTD	BGH96M060B3B	23600	11.5	16.0	24000	8.0	18600	740/540
BOVB-36HDN1-M18M	BMAC2430ANTD	BGH96M080B3B	23600	11.5	16.0	24000	8.0	18600	750/560
BOVB-36HDN1-M18M	BMAC2430BNTD	BGH96M060B3B	23800	11.7	16.0	24000	8.0	18800	760/550
BOVB-36HDN1-M18M	BMAC2430BNTD	BGH96M080B3B	24000	11.7	16.0	24000	8.0	19000	750/560
BOVB-36HDN1-M18M	BMAC3036ANTD	BGH96M060B3B	32400	9.4	16.0	34200	8.0	22800	1090/840
BOVB-36HDN1-M18M	BMAC3036ANTD	BGH96M080B3B	32400	9.4	16.0	34200	8.0	22800	1050/840
BOVB-36HDN1-M18M	BMAC3036BNTD	BGH96M060B3B	32600	9.5	16.0	34200	8.0	23000	1120/870
BOVB-36HDN1-M18M	BMAC3036BNTD	BGH96M080B3B	32600	9.5	16.0	34200	8.0	23000	1060/850
BOVB-36HDN1-M18M	BMAC3036CNTD	BGH96M080C4B	32800	9.5	16.0	34200	8.0	23000	1100/870
BOVB-36HDN1-M18M	BMAC3036CNTD	BGH96M100C5B	32800	9.5	16.0	34200	8.0	23000	1000/780
BOVB-60HDN1-M18M	BMAC4248BNTF	BGH96M080B3B	43000	10.5	16.5	45500	8.0	33000	1120/880
BOVB-60HDN1-M18M	BMAC4248CNTF	BGH96M080C4B	43000	10.8	17.0	45500	8.0	33000	1130/900
BOVB-60HDN1-M18M	BMAC4248CNTF	BGH96M100C5B	44500	10.8	17.5	47000	8.0	34000	1370/1150
BOVB-60HDN1-M18M	BMAC4248DNTF	BGH96M100D5B	45000	11.0	17.5	47000	8.0	34200	1480/1200
BOVB-60HDN1-M18M	BMAC4248DNTF	BGH96M120D5B	45000	11.0	17.5	47000	8.0	34200	1480/1200
BOVB-60HDN1-M18M	BMAC4860CNTF	BGH96M100C5B	53000	9.5	17	55000	8.5	37200	1590/1150
BOVB-60HDN1-M18M	BMAC4860DNTF	BGH96M100D5B	53500	10.0	17.5	55000	8.5	37400	1590/1150
BOVB-60HDN1-M18M	BMAC4860DNTF	BGH96M120D5B	53500	10.0	17.5	55000	8.5	37400	1590/1150

Blue Text = ENERGY STAR Certified V6.1. ❄️ = ENERGY STAR V6.1 Cold Climate and ENERGY STAR V6.1 certified. (3) Energy Efficiency Ratio; Certified per AHRI 210/240. (4) Seasonal Energy Efficiency Ratio; Certified per AHRI 210/240. (5) HSPF = Heating Seasonal Performance Factor; Certified per AHRI 210/240. Note: Always check the rating plate for electrical data on the unit being installed. The listed data is for reference only. Please consult www.bosch-homecomfort.us for further details. NOTICE: Bosch's BGH96 96% Furnace is not to be sold or installed in the State of California in the South Coast Air Quality Management District or San Joaquin Valley Air Basin territory.

BOV*20 OUTDOOR UNIT + BMAC CASED COIL + BGH96 FURNACE AHRI 210/240 - 2017 PERFORMANCE DATA

OUTDOOR UNIT MODEL	CASED COIL MODEL	PAIRING FURNACES	COOLING CAPACITY (BTU/H)			HEATING CAPACITY (BTU/H)			CFM
			TOTAL	EER ⁽³⁾	SEER ⁽⁴⁾	HI	HSPF ⁽⁵⁾	LOW	
BOV*-36HDN1-M20G	BMAC2430ANTD	BGH96M060B3B	24000	13	18.5	24000	10	18000	820/630
BOV*-36HDN1-M20G	BMAC2430ANTD	BGH96M080B3B	24000	13	18.5	24000	10	18000	800/580
BOV*-36HDN1-M20G	BMAC2430BNTD	BGH96M060B3B	24000	13.5	19	24000	10	19000	860/680
BOV*-36HDN1-M20G	BMAC2430BNTD	BGH96M080B3B	24000	13.5	19	24000	10	19000	840/630
BOV*-36HDN1-M20G	BMAC3036ANTD	BGH96M060B3B	32200	11.2	17	34000	10	25000	1050/800
BOV*-36HDN1-M20G	BMAC3036ANTD	BGH96M080B3B	32200	11.2	17	34000	10	25000	1020/800
BOV*-36HDN1-M20G	BMAC3036BNTD	BGH96M060B3B	33000	11.6	17.5	34200	10	25000	1100/850
BOV*-36HDN1-M20G	BMAC3036BNTD	BGH96M080B3B	33000	11.6	17.5	34200	10	25000	1070/850
BOV*-36HDN1-M20G	BMAC3036CNTD	BGH96M080C4B	33600	12	18	34200	10	25000	1050/820
BOV*-36HDN1-M20G	BMAC3036CNTD	BGH96M100C5B	33600	12	18	34200	10	25000	1150/750
BOV*-36HDN1-M20G	BMAC4248BNTF	BGH96M080B3B	33000	12.5	18.5	34200	10	26000	1000/850
BOV*-36HDN1-M20G	BMAC4248CNTF	BGH96M100C5B	33000	12.5	18.5	34200	10	26000	1100/800
BOV*-60HDN1-M20G	BMAC4248BNTF	BGH96M080B3B	43000	11.2	18	45000	9.5	34000	1250/1050
BOV*-60HDN1-M20G	BMAC4248CNTF	BGH96M080C4B	44000	12	18.5	46000	10	35000	1250/1050
BOV*-60HDN1-M20G	BMAC4248CNTF	BGH96M100C5B	45000	12.5	18.5	46500	10	35000	1450/1150
BOV*-60HDN1-M20G	BMAC4248DNTF	BGH96M100D5B	45500	12.5	18.5	47000	10	35000	1500/1200
BOV*-60HDN1-M20G	BMAC4248DNTF	BGH96M120D5B	45500	12.5	18.5	47000	10	35000	1500/1200
BOV*-60HDN1-M20G	BMAC4860CNTF	BGH96M100C5B	52000	12	18	53500	10	37000	1450/1150
BOV*-60HDN1-M20G	BMAC4860DNTF	BGH96M100D5B	52000	12.5	18.5	54000	10	38000	1500/1200
BOV*-60HDN1-M20G	BMAC4860DNTF	BGH96M120D5B	52000	12.5	18.5	54000	10	38000	1500/1200

BOV*20 OUTDOOR UNIT + BMAC CASED COIL + BGH96 FURNACE AHRI 210/240 - 2023 PERFORMANCE DATA

OUTDOOR UNIT MODEL	CASED COIL MODEL	PAIRING FURNACES	COOLING CAPACITY (BTU/H)			HEATING CAPACITY (BTU/H)			CFM
			TOTAL	EER ⁽³⁾	SEER ⁽⁴⁾	HI	HSPF ⁽⁵⁾	LOW	
❄️ BOV*-36HDN1-M20G	BMAC2430ANTD	BGH96M060B3B	23800	12.0	18.0	24000	9.0	19600	740/540
❄️ BOV*-36HDN1-M20G	BMAC2430ANTD	BGH96M080B3B	23800	12.0	18.0	24000	9.0	19600	750/560
❄️ BOV*-36HDN1-M20G	BMAC2430BNTD	BGH96M060B3B	24000	12.0	18.5	24000	9.0	20000	760/550
❄️ BOV*-36HDN1-M20G	BMAC2430BNTD	BGH96M080B3B	24000	12.0	18.5	24000	9.0	20000	750/560
BOV*-36HDN1-M20G	BMAC3036ANTD	BGH96M060B3B	32800	10.6	17.5	34000	9.0	25000	1090/840
BOV*-36HDN1-M20G	BMAC3036ANTD	BGH96M080B3B	32800	10.6	17.5	34000	9.0	25000	1050/840
BOV*-36HDN1-M20G	BMAC3036BNTD	BGH96M060B3B	33600	11.0	17.5	34200	9.0	25000	1120/870
BOV*-36HDN1-M20G	BMAC3036BNTD	BGH96M080B3B	33600	11.0	17.5	34200	9.0	25000	1060/850
BOV*-36HDN1-M20G	BMAC3036CNTD	BGH96M080C4B	33600	11.0	17.5	34200	9.0	25000	1100/870
BOV*-36HDN1-M20G	BMAC3036CNTD	BGH96M100C5B	33200	11.2	17.5	34200	9.0	25000	1000/780
BOV*-36HDN1-M20G	BMAC4248BNTF	BGH96M080B3B	33000	11.2	18.5	34200	9.0	25600	1100/880
BOV*-36HDN1-M20G	BMAC4248CNTF	BGH96M100C5B	33000	12.0	18.5	34200	9.0	25600	1060/840
❄️ BOV*-60HDN1-M20G	BMAC4248BNTF	BGH96M080B3B	42500	11.7	17.0	43500	8.8	35000	1120/880
❄️ BOV*-60HDN1-M20G	BMAC4248CNTF	BGH96M080C4B	42500	11.7	17.0	44500	8.8	35000	1130/900
❄️ BOV*-60HDN1-M20G	BMAC4248CNTF	BGH96M100C5B	45000	11.7	17.5	46500	8.8	35600	1370/1150
❄️ BOV*-60HDN1-M20G	BMAC4248DNTF	BGH96M100D5B	45500	11.7	17.5	47000	9.0	35600	1480/1200
❄️ BOV*-60HDN1-M20G	BMAC4248DNTF	BGH96M120D5B	45500	11.7	17.5	47000	9.0	35600	1480/1200
BOV*-60HDN1-M20G	BMAC4860CNTF	BGH96M100C5B	51500	11.4	18.0	53500	8.5	38000	1370/1150
BOV*-60HDN1-M20G	BMAC4860DNTF	BGH96M100D5B	52000	11.7	18.0	54000	8.5	38500	1460/1170
BOV*-60HDN1-M20G	BMAC4860DNTF	BGH96M120D5B	52000	11.7	18.0	54000	8.5	38500	1460/1170

Blue Text = ENERGY STAR Certified V6.1. ❄️ = ENERGY STAR V6.1 Cold Climate and ENERGY STAR V6.1 certified. (3) Energy Efficiency Ratio; Certified per AHRI 210/240. (4) Seasonal Energy Efficiency Ratio; Certified per AHRI 210/240. (5) HSPF = Heating Seasonal Performance Factor; Certified per AHRI 210/240. Note: Always check the rating plate for electrical data on the unit being installed. The listed data is for reference only. Please consult www.bosch-homecomfort.us for further details. NOTICE: Bosch's BGH96 96% Furnace is not to be sold or installed in the State of California in the South Coast Air Quality Management District or San Joaquin Valley Air Basin territory.

BOVB18 OUTDOOR UNIT + BMAC CASED COIL ONLY AHRI 210/240 - 2017 PERFORMANCE DATA

OUTDOOR UNIT MODEL	CASED COIL MODEL	COOLING CAPACITY (BTU/H)			HEATING CAPACITY (BTU/H)			CFM
		TOTAL	EER ⁽³⁾	SEER ⁽⁴⁾	HI	HSPF ⁽⁵⁾	LOW	
BOVB-36HDN1-M18M	BMAC2430ANTD	23400	11.5	15	24000	9	17200	700
BOVB-36HDN1-M18M	BMAC2430BNTD	23400	11.5	15	24000	9	17200	700
BOVB-36HDN1-M18M	BMAC3036ANTD	32000	10	14.5	35000	9	22000	900
BOVB-36HDN1-M18M	BMAC3036BNTD	32400	10	14.5	35000	9	23000	1000
BOVB-36HDN1-M18M	BMAC3036CNTD	32400	10	14.5	35000	9	23000	1000
BOVB-36HDN1-M18M	BMAC4248BNTF	32400	10	15	35000	9	23000	1000
BOVB-36HDN1-M18M	BMAC4248CNTF	32400	10	15	35000	9	23000	1000
BOVB-60HDN1-M18M	BMAC4248BNTF	44500	11	16	45500	9.5	31000	1150
BOVB-60HDN1-M18M	BMAC4248CNTF	46000	11	16	47000	9.5	32000	1300
BOVB-60HDN1-M18M	BMAC4248DNTF	46000	11	16	48000	9.5	32000	1400
BOVB-60HDN1-M18M	BMAC4860CNTF	54000	10.5	16	55500	9.5	32000	1300
BOVB-60HDN1-M18M	BMAC4860DNTF	55000	10.5	16	56000	9.5	39000	1500

BOVB18 OUTDOOR UNIT + BMAC CASED COIL ONLY AHRI 210/240 - 2023 PERFORMANCE DATA

OUTDOOR UNIT MODEL	CASED COIL MODEL	COOLING CAPACITY (BTU/H)			HEATING CAPACITY (BTU/H)			CFM
		TOTAL	EER ⁽³⁾	SEER ⁽⁴⁾	HI	HSPF ⁽⁵⁾	LOW	
BOVB-60HDN1-M18M	BMAC4248BNTF	43500	10.8	14.5	46000	8.5	32800	1140
BOVB-60HDN1-M18M	BMAC4248CNTF	44500	10.8	14.3	47000	8.5	33000	1300
BOVB-60HDN1-M18M	BMAC4248DNTF	45000	10.8	14.3	48000	8.5	33000	1400
BOVB-60HDN1-M18M	BMAC4860CNTF	53000	10.2	14.6	54500	8.0	37000	1300
BOVB-60HDN1-M18M	BMAC4860DNTF	54000	10.2	14.6	56000	8.0	37400	1500

BOV*20 OUTDOOR UNIT + BMAC CASED COIL ONLY AHRI 210/240 - 2017 PERFORMANCE DATA

OUTDOOR UNIT MODEL	CASED COIL MODEL	COOLING CAPACITY (BTU/H)			HEATING CAPACITY (BTU/H)			CFM
		TOTAL	EER ⁽³⁾	SEER ⁽⁴⁾	HI	HSPF ⁽⁵⁾	LOW	
BOV*-36HDN1-M20G	BMAC2430ANTD	23400	11.8	16	23400	9.5	18000	750
BOV*-36HDN1-M20G	BMAC2430BNTD	23600	11.8	16	23800	9.5	18000	800
BOV*-36HDN1-M20G	BMAC3036ANTD	32000	10.8	16	33600	9.5	22000	900
BOV*-36HDN1-M20G	BMAC3036BNTD	32400	11.2	16	33800	9.5	23000	1000
BOV*-36HDN1-M20G	BMAC3036CNTD	32600	11.4	16	34000	9.5	23000	1050
BOV*-36HDN1-M20G	BMAC4248BNTF	33000	11.2	16	33800	9.5	24000	1000
BOV*-36HDN1-M20G	BMAC4248CNTF	33200	11.2	16	34200	9.5	24000	1050
BOV*-36HDN1-M20G	BMAC4248DNTF	33400	11.2	16	34200	9.5	24000	1100
BOV*-60HDN1-M20G	BMAC4248BNTF	43000	11.2	16	45500	9.5	31400	1200
BOV*-60HDN1-M20G	BMAC4248CNTF	44000	11.8	16	46500	9.5	32000	1350
BOV*-60HDN1-M20G	BMAC4248DNTF	45000	11.8	16	47500	9.5	32000	1450
BOV*-60HDN1-M20G	BMAC4860CNTF	55000	10.5	16	55500	9.5	38000	1350
BOV*-60HDN1-M20G	BMAC4860DNTF	56000	10.5	16	56000	9.5	39000	1500

BOV*20 OUTDOOR UNIT + BMAC CASED COIL ONLY AHRI 210/240 - 2023 PERFORMANCE DATA

OUTDOOR UNIT MODEL	CASED COIL MODEL	COOLING CAPACITY (BTU/H)			HEATING CAPACITY (BTU/H)			CFM
		TOTAL	EER ⁽³⁾	SEER ⁽⁴⁾	HI	HSPF ⁽⁵⁾	LOW	
BOV*-36HDN1-M20G	BMAC2430ANTD	23200	12.0	15.2	24000	9.0	19400	750
BOV*-36HDN1-M20G	BMAC2430BNTD	23400	12.0	15.2	24000	9.0	19400	750
BOV*-36HDN1-M20G	BMAC3036ANTD	32000	10.6	15.0	34000	9.0	23400	900
BOV*-36HDN1-M20G	BMAC3036BNTD	32400	11.0	15.0	34200	9.0	23600	900
BOV*-36HDN1-M20G	BMAC3036CNTD	32600	11.0	15.0	34200	9.0	23600	1050
BOV*-36HDN1-M20G	BMAC4248BNTF	33400	11.4	15.0	34000	9.0	24600	1000
BOV*-36HDN1-M20G	BMAC4248CNTF	33600	11.4	15.0	34200	9.0	25000	1050
BOV*-36HDN1-M20G	BMAC4248DNTF	33800	11.4	15.0	34200	9.0	25000	1100
BOV*-60HDN1-M20G	BMAC4248BNTF	44000	11.7	14.4	46000	8.8	33000	1200
BOV*-60HDN1-M20G	BMAC4248CNTF	44500	11.7	14.4	46500	8.8	33000	1350
BOV*-60HDN1-M20G	BMAC4248DNTF	45000	11.7	14.4	47500	8.8	33200	1450
BOV*-60HDN1-M20G	BMAC4860CNTF	53000	10.8	14.5	55500	8.2	38500	1350
BOV*-60HDN1-M20G	BMAC4860DNTF	54000	10.8	14.7	56000	8.2	39000	1460

Blue Text = ENERGY STAR Certified V6.1. ❄️ = ENERGY STAR V6.1 Cold Climate and ENERGY STAR V6.1 certified. (3) Energy Efficiency Ratio; Certified per AHRI 210/240. (4) Seasonal Energy Efficiency Ratio; Certified per AHRI 210/240. (5) HSPF = Heating Seasonal Performance Factor; Certified per AHRI 210/240. Note: Always check the rating plate for electrical data on the unit being installed. The listed data is for reference only. Please consult www.bosch-homecomfort.us for further details. NOTICE: Bosch's BGH96 96% Furnace is not to be sold or installed in the State of California in the South Coast Air Quality Management District or San Joaquin Valley Air Basin territory.



The Bosch IDS compact air handlers are designed for multi-family construction and limited space applications. These systems provide exceptional and efficient heating or cooling, backed with a 10-Year warranty.[§]

Bosch IDS Ceiling & Wall Mounted Air Handlers

The best comfort solution when space is limited

Bosch offers three different air handlers that pair seamlessly with the IDS Light condensing section. This allows you to pick the perfect system for your application, whether that is a standard Bosch BVA air handler or a compact BWA, or a BCA air handler. All three configurations work in tandem with your thermostat to automatically adjust to your preferences, while integrated sound dampening features keep the equipment quiet for your peace of mind.



- ▶ The first 15-SEER Inverter condenser on the market.
- ▶ With IDS Light, you get the comfort of our inverter system at a price point you'll love!
- ▶ This system combines the standard efficiency BOVA15 outdoor unit with our BVA15 fixed-speed air handler.



- ▶ A versatile wall-mounted air handler paired with an inverter condenser to create a space saving comfort solution.
- ▶ This system combines the BOVA15 outdoor unit with our BWA16 constant torque air handler.

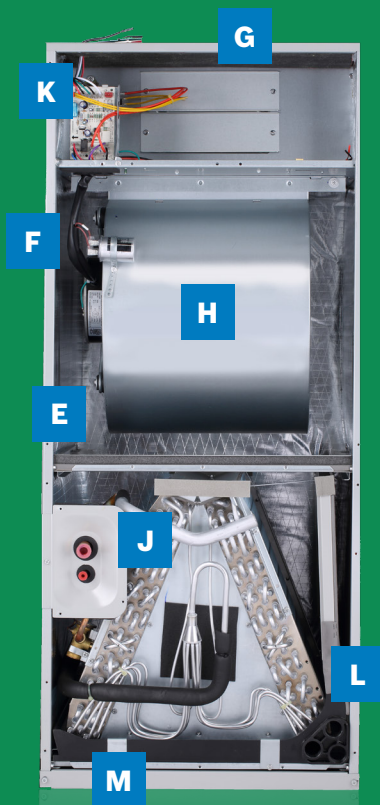

- ▶ A compact ceiling-mounted air handler combined with an inverter condenser to create a powerful combination.
- ▶ This system combines the BOVA15 outdoor unit with our BCA16 constant torque air handler.

Bosch BVA15

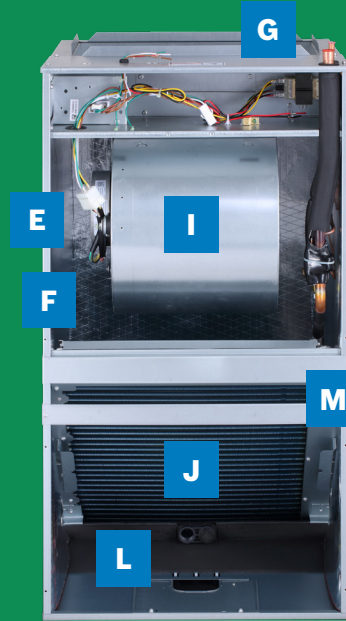
 Robust & Reliable
Indoor Air Handler

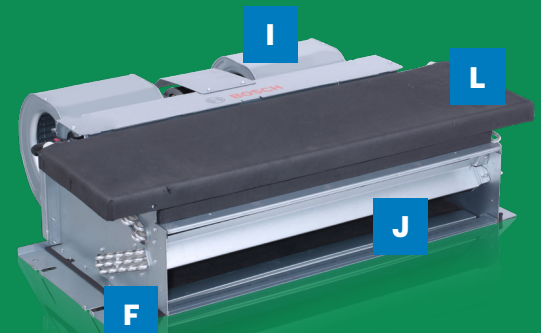
Bosch BWA16

 Space Saving & Easy Access
Indoor Wall Mounted Air Handler

Bosch BCA16

 Compact & Powerful
Indoor Ceiling Mounted Air Handler

E Material – Foil-faced insulation material on the inner walls decreases energy loss and reduces condensation.

F Cabinets – The BVA cabinets are painted steel, while the BWA and BCA cabinets are unpainted galvanized steel.

G Electric Heat – Can accommodate electric heat with no modification to the cabinet for additional heat on-demand when you need it most.

H PSC style motor in the Bosch BVA15 – simple and cost-effective solution.

I Constant torque ECM motor in the Bosch BWA16 and BCA16 – provides enhanced comfort, energy savings, and superior humidity control.

J All-Aluminum Coil – With excellent heat transfer, efficiency, and humidity removal, the coil is more durable and has a lower chance of refrigerant leakage compared to typical copper coils.

K Control Board Pocket – A dedicated slot for the control board protects it from humidity in the airstream and extends its lifetime.

L Integrated Drain Pan – Made from corrosion-resistant composite material, gently sloped to reduce standing water. On BVA15 the drain pan functions in both HZ and VT applications.

M Filter Rack – Factory reserved, provides convenience for field installation and serviceability.

Before Everything, There's Bosch.

 Bosch Offers Reliable Energy Efficient HVAC Products,
That are Simple to Install and Support Readily Available!



IDS Light BOVA15 + BVA15 15 SEER System

- ▶ The first 15-SEER Inverter condenser solution on the market. With IDS Light, you get the comfort of our inverter system at a price point you'll love!
- ▶ This system combines the robust design & efficiency of the BOVA15 outdoor unit with our BVA15 fixed-speed air handler.

IDS LIGHT BOVA15 + BVA15 AHRI 210/240 - 2023 PERFORMANCE DATA

OUTDOOR UNIT MODEL	INDOOR AIR HANDLER MODEL	COOLING CAPACITY (BTU/H)			HEATING CAPACITY (BTU/H)			CFM
		TOTAL	EER2 ⁽³⁾	SEER2 ⁽⁴⁾	HI	HSPF2 ⁽⁵⁾	LOW	
BOVA-24HDN1-M15G	BVA-24WN1-M15	24000	10.6	14.5	24000	8	20000	780
BOVA-36HDN1-M15G	BVA-24WN1-M15	24000	11.2	14.8	24000	8.2	20600	780
BOVA-36HDN1-M15G	BVA-36WN1-M15	34200	10	14.5	34600	8	25000	1210
BOVA-60HDN1-M15G	BVA-48WN1-M15	46500	10.6	14.3	48000	8	38000	1530
BOVA-60HDN1-M15G	BVA-60WN1-M15	54500	9.8	14.3	56000	8	40500	1680



IDS Light Compact Wall BOVA15 + BWA16 16 SEER2 System

- ▶ A versatile wall-mounted air handler paired with an inverter condenser to create a flexible solution.
- ▶ This system combines the BOVA15 outdoor unit with our BWA16 constant torque air handler.

IDS LIGHT BOVA15 + BWA15 AHRI 210/240 - 2023 PERFORMANCE DATA

OUTDOOR UNIT MODEL	INDOOR AIR HANDLER MODEL	COOLING CAPACITY (BTU/H)			HEATING CAPACITY (BTU/H)			CFM
		TOTAL	EER2 ⁽³⁾	SEER2 ⁽⁴⁾	HI	HSPF2 ⁽⁵⁾	LOW	
BOVA-24HDN1-M15G	BWA-18WN1-M16	18000	11.7	16.1	18000	9	15000	640
BOVA-24HDN1-M15G	BWA-24WN1-M16	23800	10.5	15.2	23800	9	20200	820
BOVA-36HDN1-M15G	BWA-30WN1-M16	29400	12	16.1	29400	9	21400	1100
BOVA-36HDN1-M15G	BWA-36WN1-M16	34000	10.6	16.1	34000	9	24800	1120



IDS Light Compact Ceiling BOVA15 + BCA16 16 SEER2 System

- ▶ A compact ceiling-mounted air handler combined with an inverter condenser to create a powerful combination.
- ▶ This system combines the BOVA15 outdoor unit with our BCA16 constant torque air handler.

IDS LIGHT BOCA15 + BVA15 - 2023 PERFORMANCE DATA

OUTDOOR UNIT MODEL	INDOOR AIR HANDLER MODEL	COOLING CAPACITY (BTU/H)			HEATING CAPACITY (BTU/H)			CFM
		TOTAL	EER2 ⁽³⁾	SEER2 ⁽⁴⁾	HI	HSPF2 ⁽⁵⁾	LOW	
BOVA-24HDN1-M15G	BCA-18WN1-M16	18000	11.7	16.1	18000	9	15000	650
BOVA-24HDN1-M15G	BCA-24WN1-M16	23400	11.7	16.1	23600	8.5	20200	820
BOVA-36HDN1-M15G	BCA-30WN1-M16	27800	10.6	16.1	28000	8.5	21000	950
BOVA-36HDN1-M15G	BCA-36WN1-M16	33800	10.5	16.1	33800	8.2	24200	1100

Blue Text = ENERGY STAR Certified V6.1. ❄️ = ENERGY STAR V6.1 Cold Climate and ENERGY STAR V6.1 certified. (3) Energy Efficiency Ratio 2; Certified per AHRI 210/240. (4) Seasonal Energy Efficiency Ratio 2; Certified per AHRI 210/240. (5) HSPF2 = Heating Seasonal Performance Factor 2; Certified per AHRI 210/240. Note: Always check the rating plate for electrical data on the unit being installed. The listed data is for reference only. Please consult www.bosch-homecomfort.us for further details. ♦ Visit www.bosch-homecomfort.us to find the available efficiency rebates in your area.

IDS Family System & Technical Information

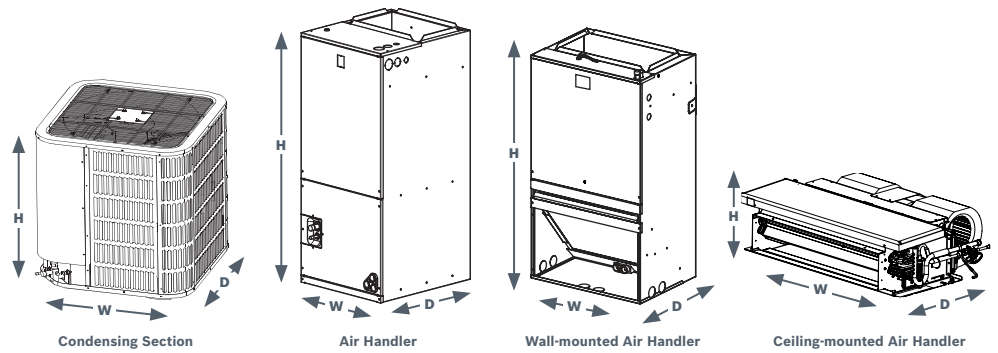

BOSCH IDS FAMILY DESCRIPTION & DIMENSIONS^P

MODEL NUMBER	DESCRIPTION	PART NUMBER	WIDTH (W)	HEIGHT (H)	DEPTH (D)
BOVA15 OUTDOOR CONDENSING SECTION					
NEW BOVA-24HDN1-M15G	24 kBTU/hr (2 ton)	8733956368	28	24.9375	28
NEW BOVA-36HDN1-M15G	36 kBTU/hr (3 ton)	8733955693	28	24.9375	28
NEW BOVA-60HDN1-M15G	60 kBTU/hr (5 ton)	8733955694	29.125	33.1875	29.125
BVA15 INDOOR AIR HANDLER					
BVA-24WN1-M15	24 kBTU/hr (2 ton)	8733955038	19.625	46.5	21.625
BVA-36WN1-M15	36 kBTU/hr (3 ton)	8733955039	19.625	46.5	21.625
BVA-48WN1-M15	48 kBTU/hr (4 ton)	8733955040	22.0	54.5	24.0
BVA-60WN1-M15	60 kBTU/hr (5 ton)	8733955041	22.0	54.5	24.0
BWA16 INDOOR AIR HANDLER					
NEW BWA-18WN1-M16	18 kBTU/hr (1.5 ton)	8733958523	20.5	36.5	15
NEW BWA-24WN1-M16	24 kBTU/hr (2 ton)	8733958524	20.5	36.5	15
NEW BWA-30WN1-M16	30 kBTU/hr (2.5 ton)	8733958525	22	39.5	19
NEW BWA-36WN1-M16	36 kBTU/hr (3 ton)	8733958526	22	39.5	19
BCA16 INDOOR AIR HANDLER					
NEW BCA-18WN1-M16	18 kBTU/hr (1.5 ton)	8733958519	37.25	10.5625	26.3125
NEW BCA-24WN1-M16	24 kBTU/hr (2 ton)	8733958520	37.25	10.5625	26.3125
NEW BCA-30WN1-M16	30 kBTU/hr (2.5 ton)	8733958521	49.25	10.5625	26.3125
NEW BCA-36WN1-M16	36 kBTU/hr (3 ton)	8733958522	49.25	10.5625	26.3125



Bosch IDS heat pumps are highly efficient heating and cooling systems that utilize advanced technology to provide reliable and energy-efficient climate control for residential and commercial applications

(D) Dimensions in inches § Please go to www.bosch-homecomfort.us for full limited warranty details

About Bosch

Bosch Home Comfort Group in North America

Bosch Home Comfort Group is a leading source of high quality water heating and comfort systems. The company offers gas tankless, electric whole house and point-of-use water heaters, Bosch and Buderus floor-standing and wall-mounted boilers, Bosch and FHP geothermal, water-source and air-source systems as well as controls and accessories for all product lines. Bosch Home Comfort is committed to being Simply Smart by offering products that work together as integrated systems that enhance quality of life in an ultra-efficient and environmentally friendly manner. For more information, visit bosch-homecomfort.us.

Bosch Group

The Bosch Group is a leading global supplier of technology and services in the areas of Automotive, Industrial Technology, Consumer Goods and Building Technology. The company was founded in Stuttgart, Germany, in 1886 and presently has more than 440 subsidiaries and is represented in over 150 countries.

In the U.S., Canada and Mexico, the Bosch Group manufactures and markets automotive original equipment and aftermarket solutions, industrial drives and control technology, power tools, security and communication systems, packaging technology, home comfort solutions, household appliances and software solutions. The Bosch Group's products and services are designed to improving quality of life by providing innovative and beneficial solutions. In this way, the company offers technology worldwide that is Invented for life. Additional information is available online at www.bosch.com



Bosch Home Comfort Group

Watertown, MA | Londonderry, NH | Ft. Lauderdale, FL

General Inquiries: 1-866-642-3198

Copyright © 2023 Bosch Home Comfort Group
All rights reserved. Subject to change without notice.

76H991858R 6-23

www.bosch-homecomfort.us